

# **SNCF Class BB 75000**

Model by Denis Huot  
Instructions by Didier Enjary

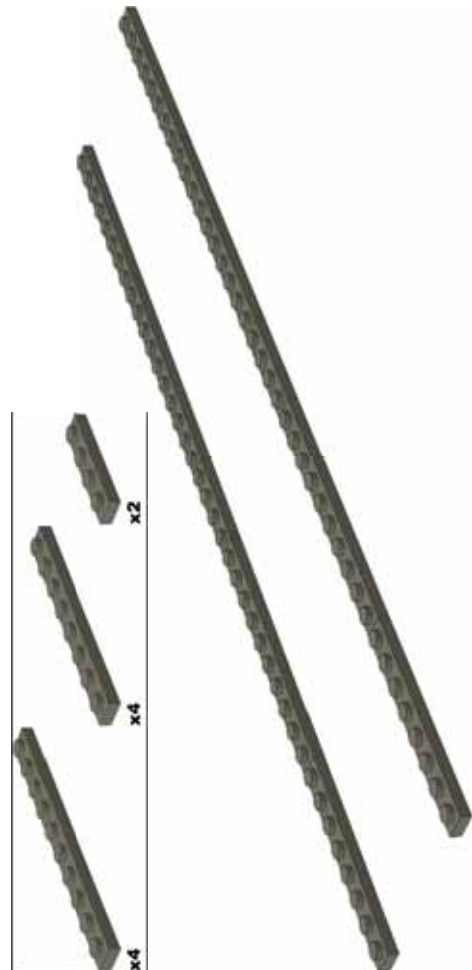

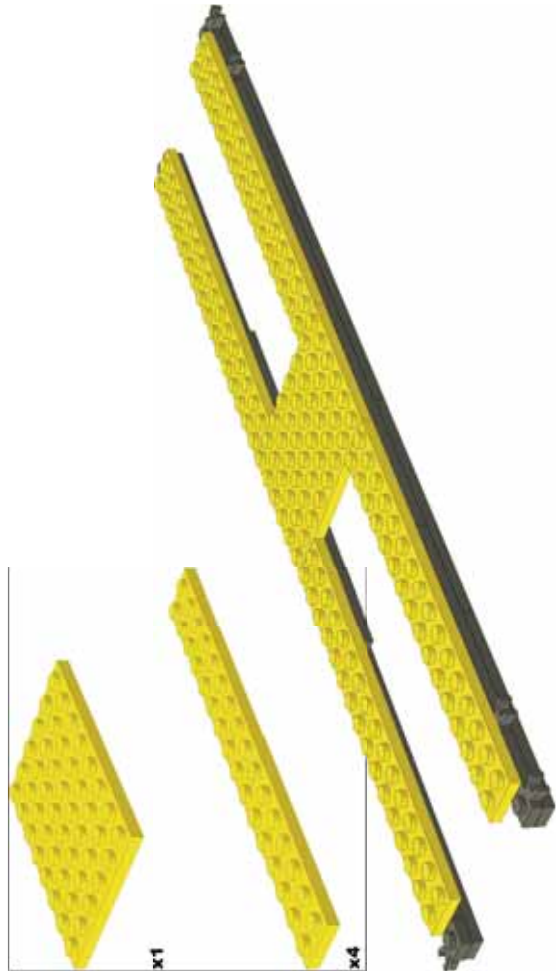

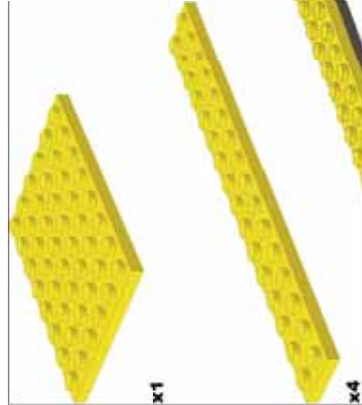
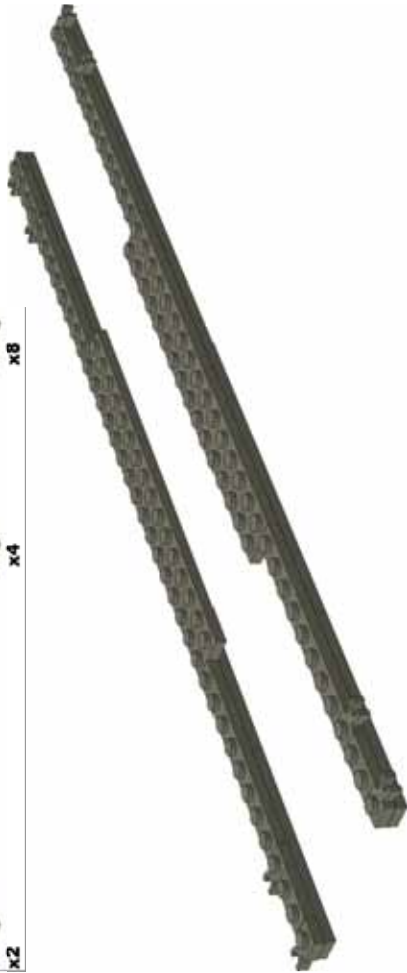
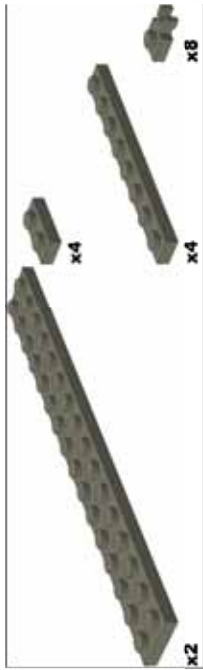
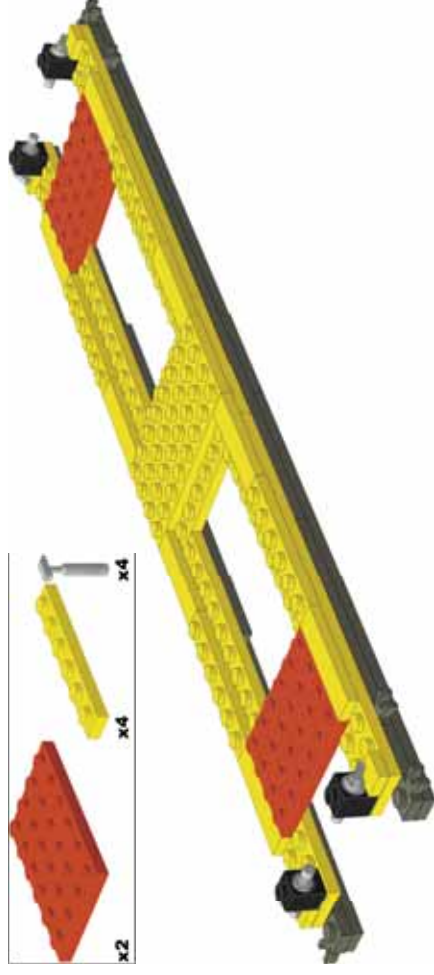
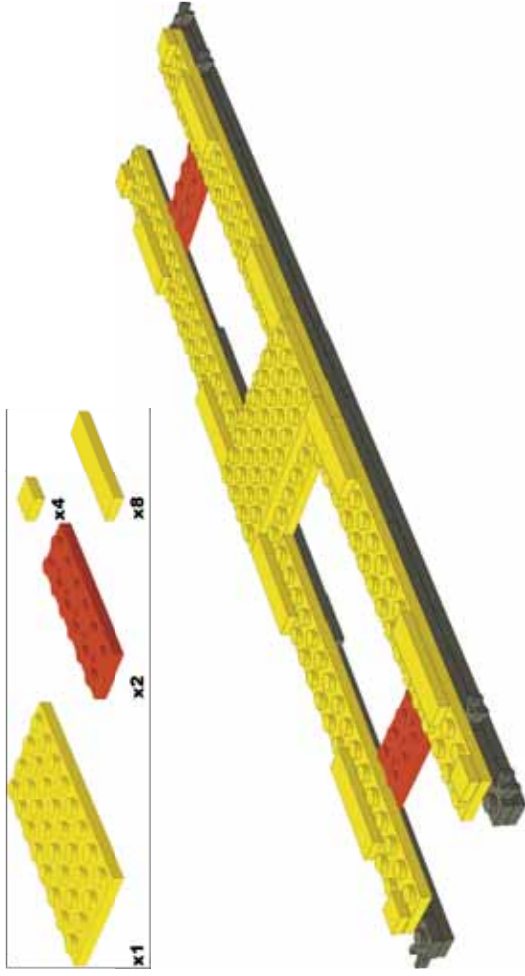

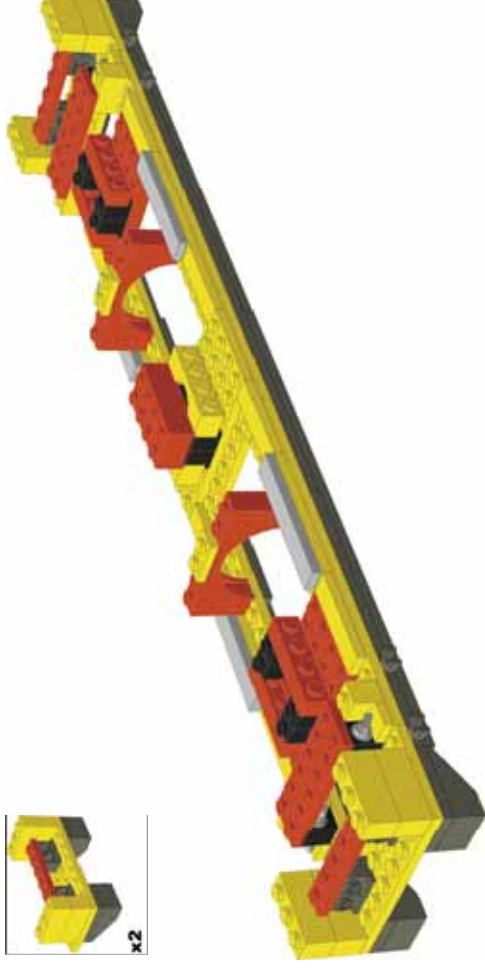
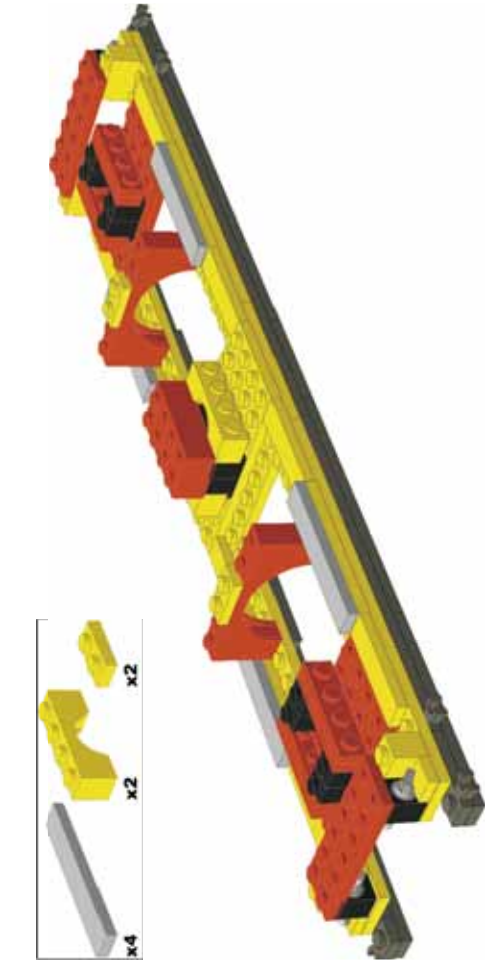
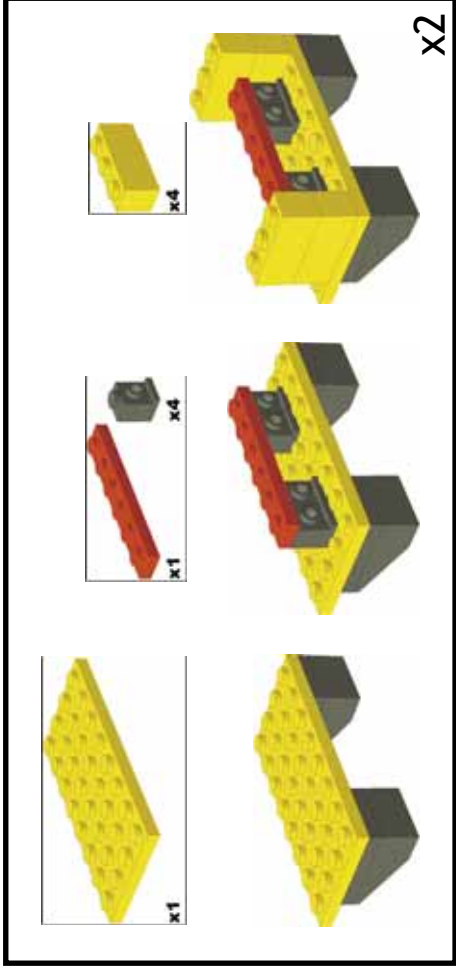
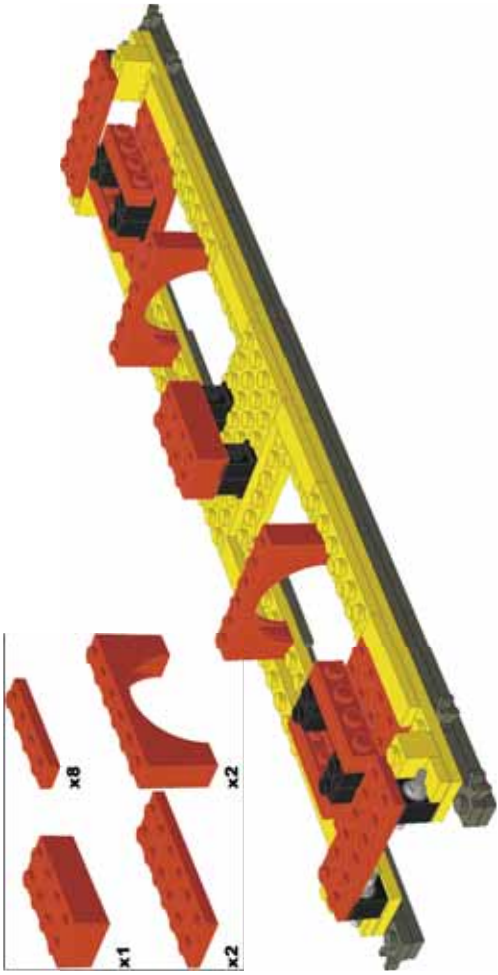

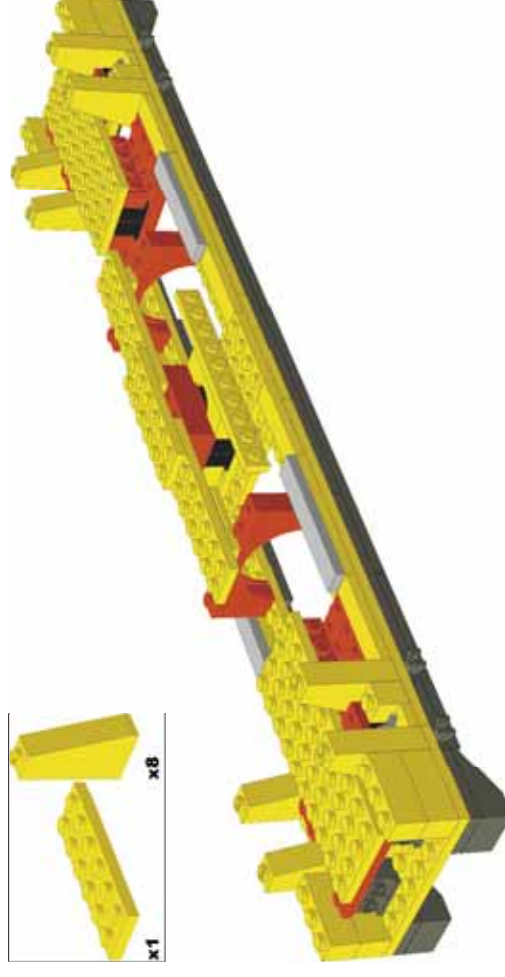
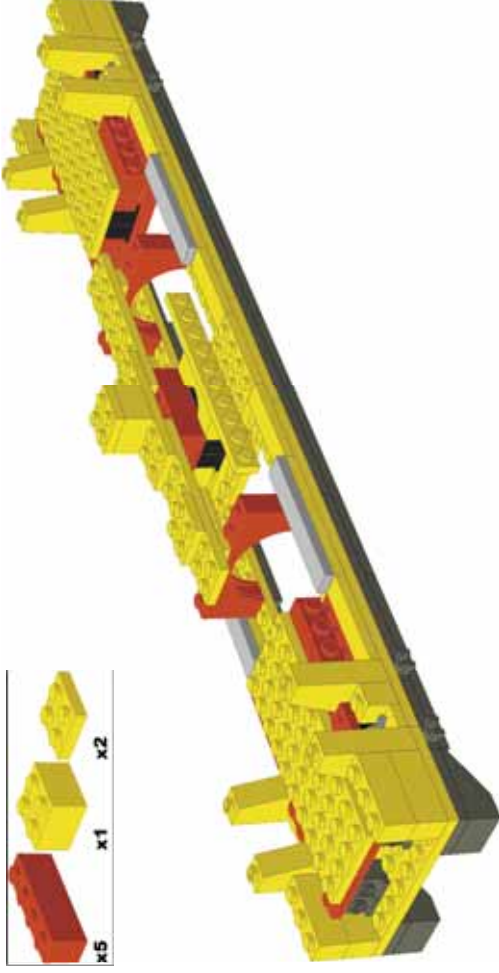
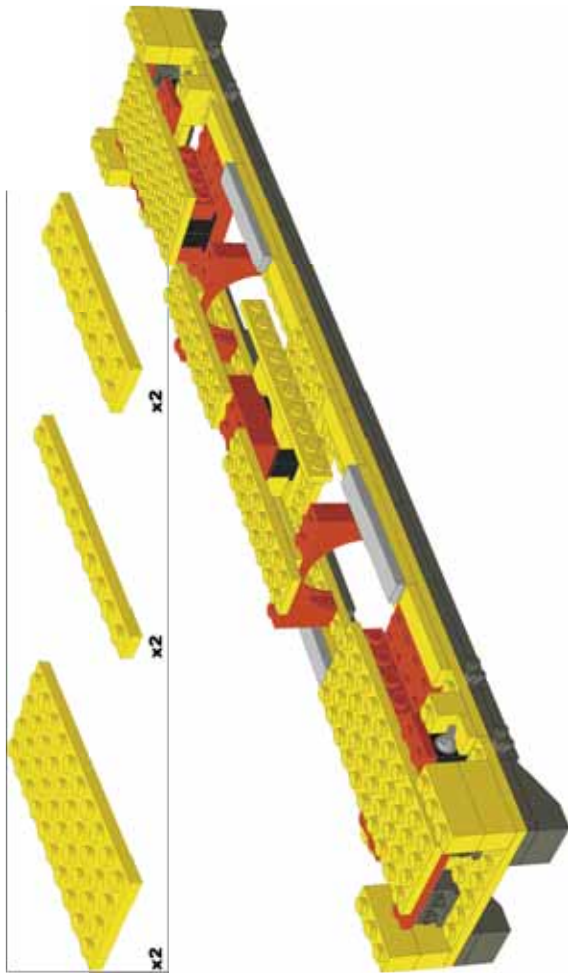

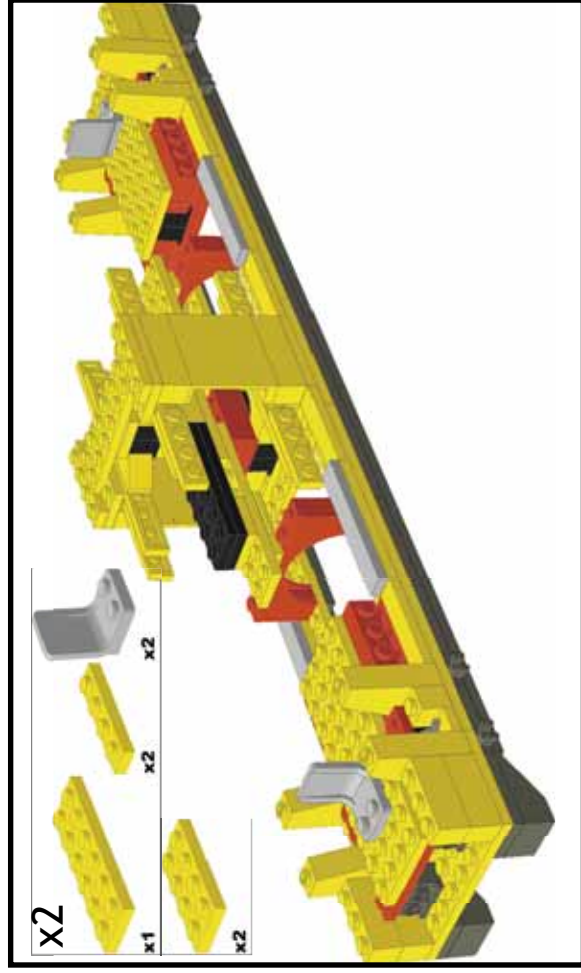
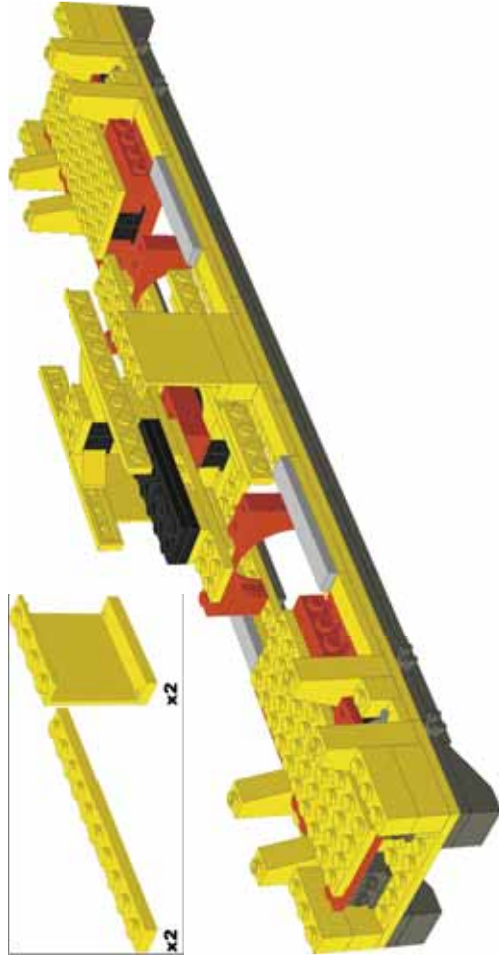
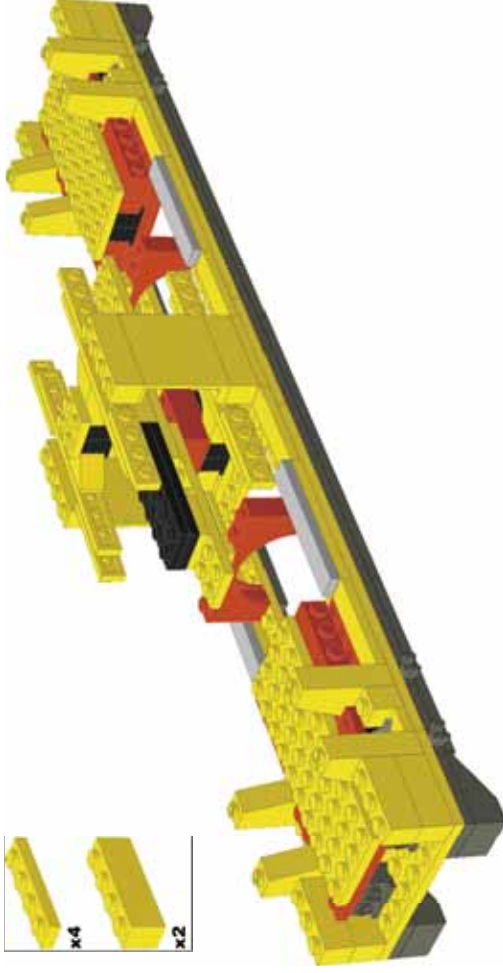
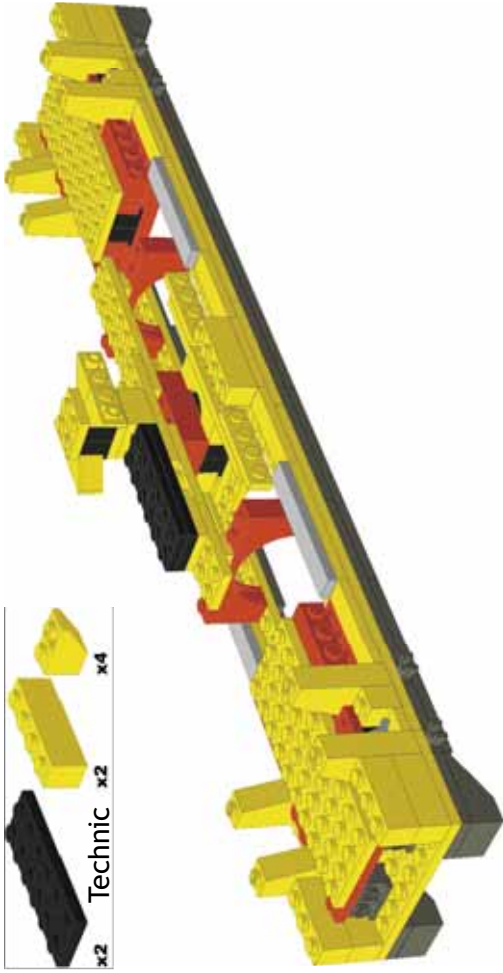

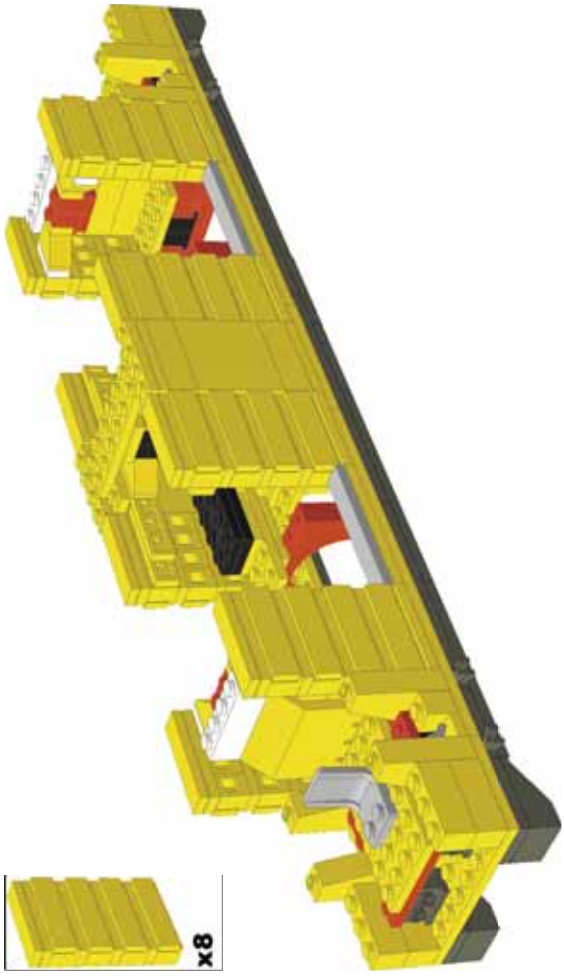
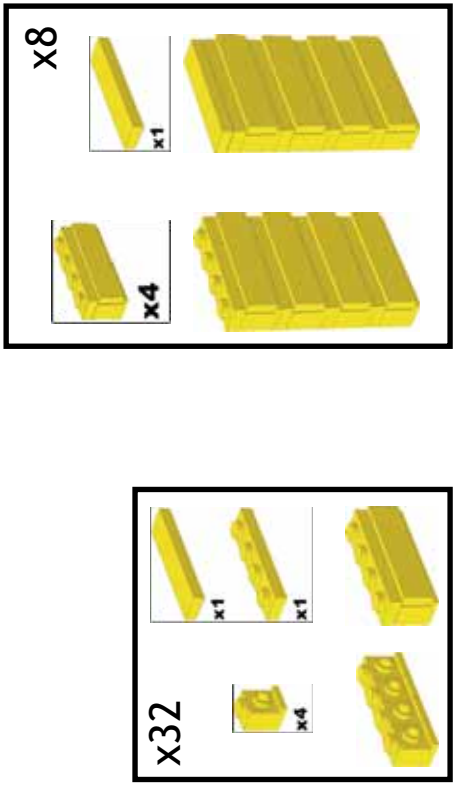
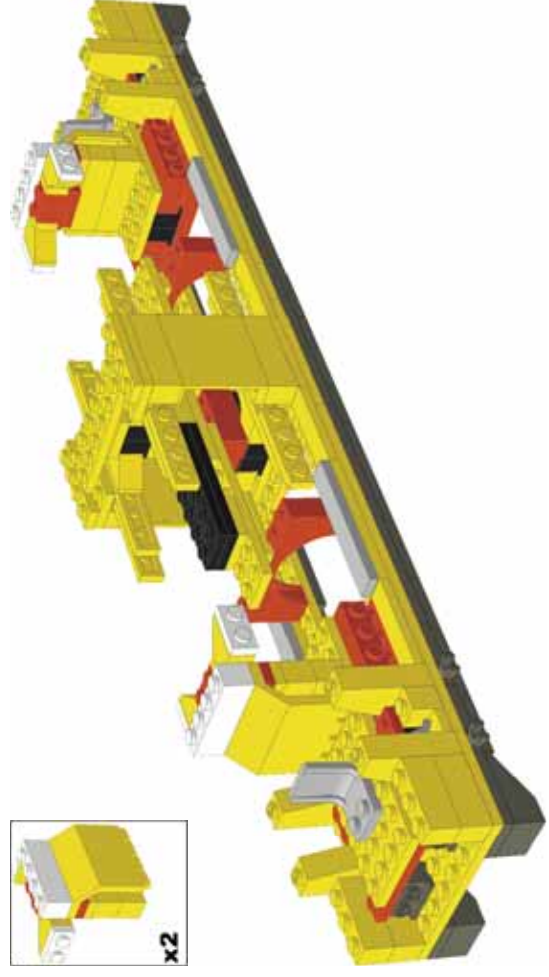
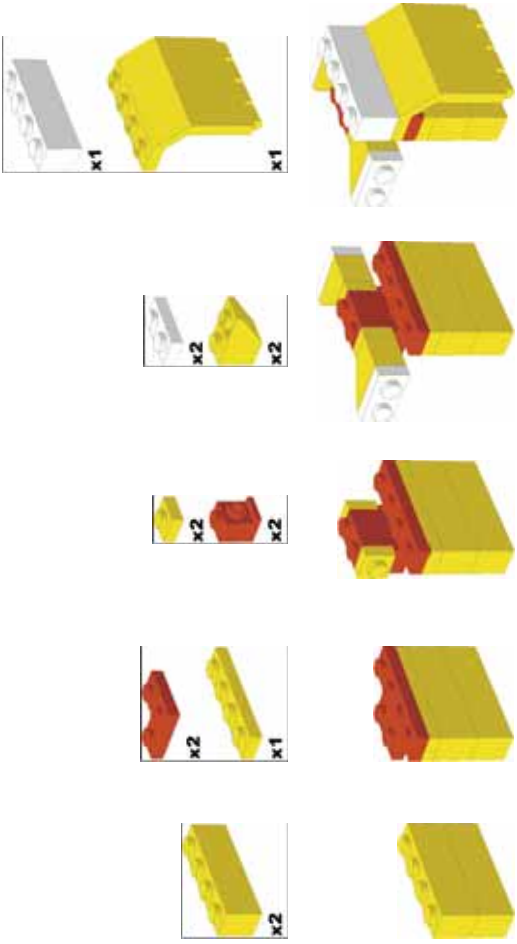

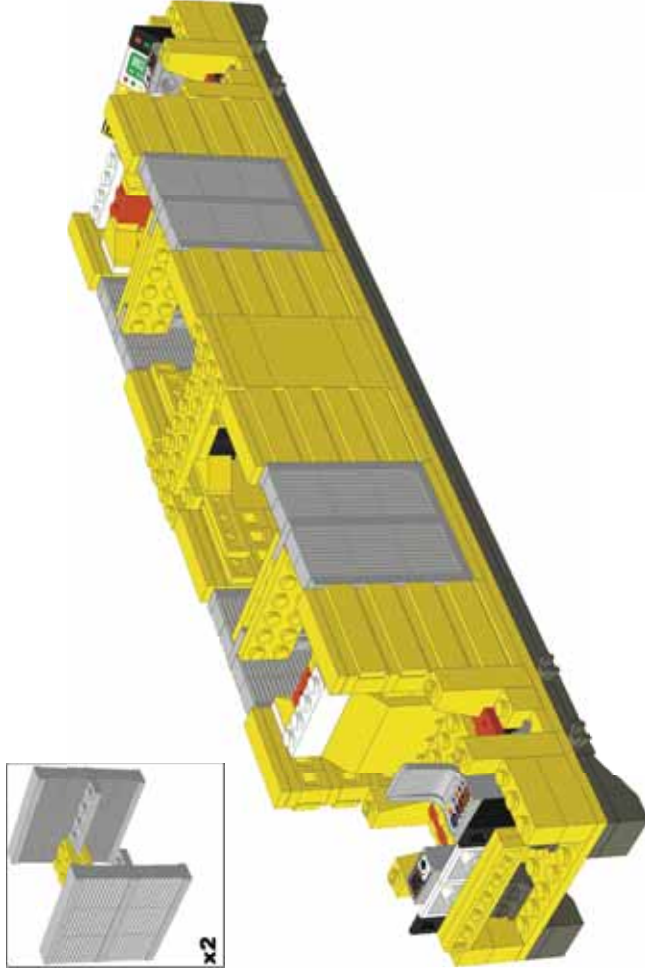
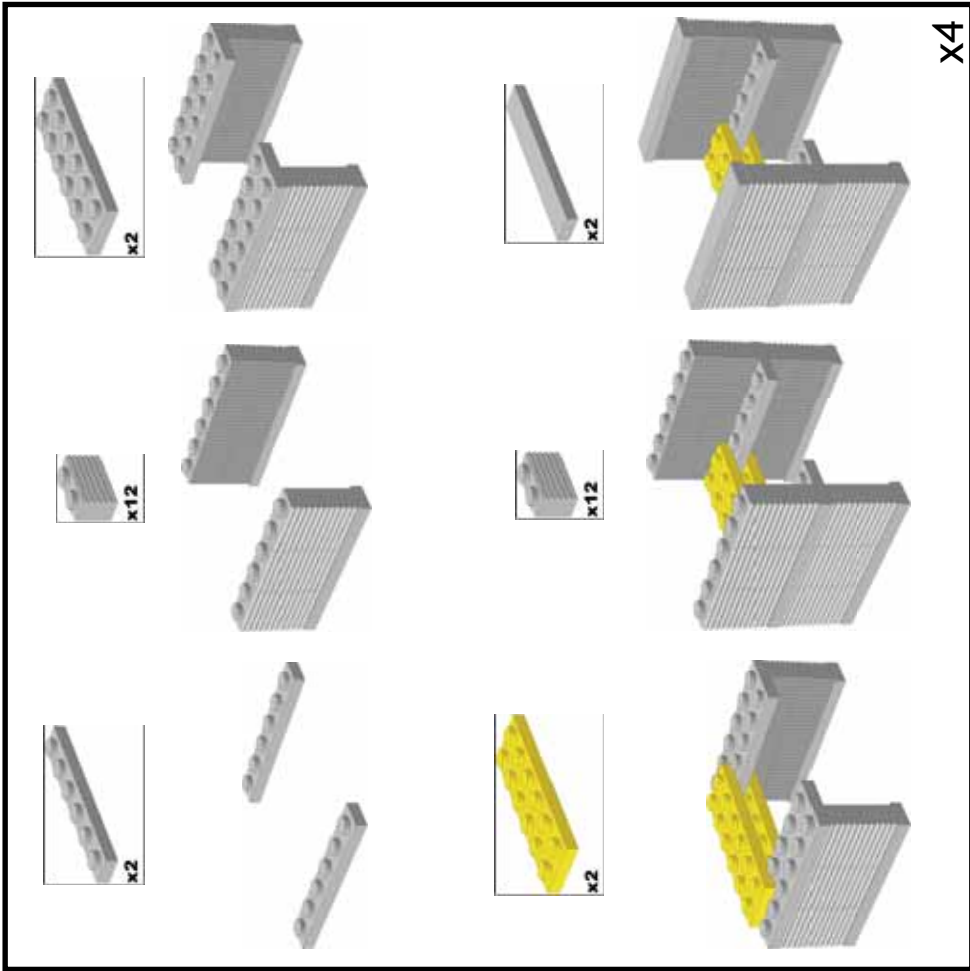



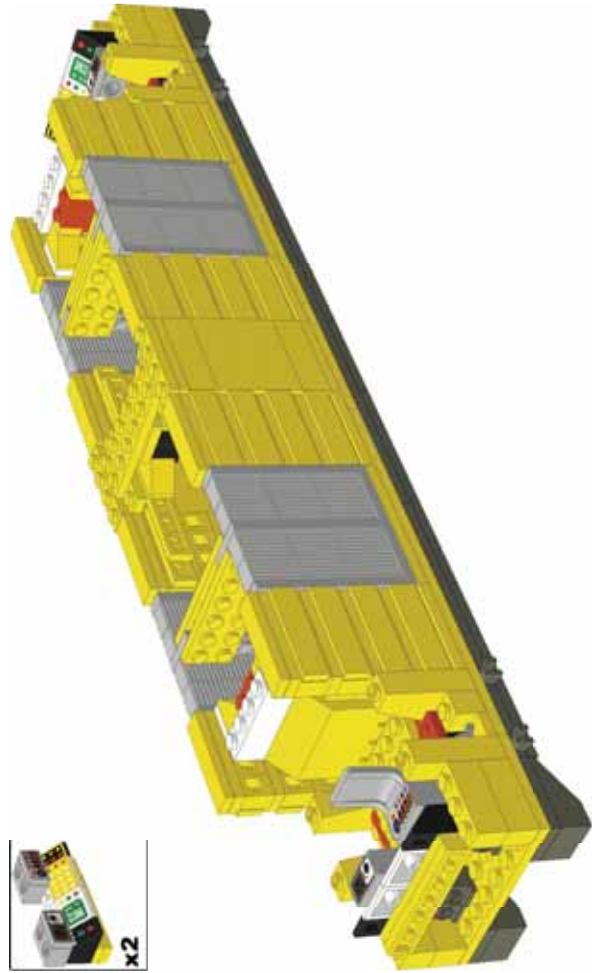
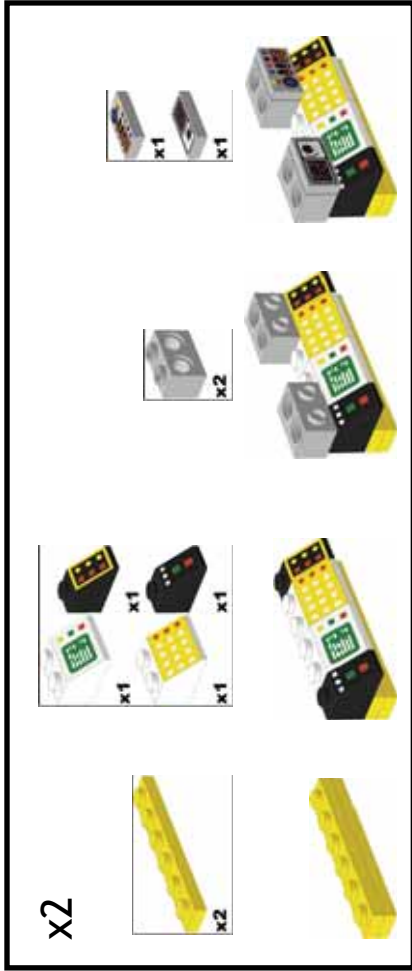
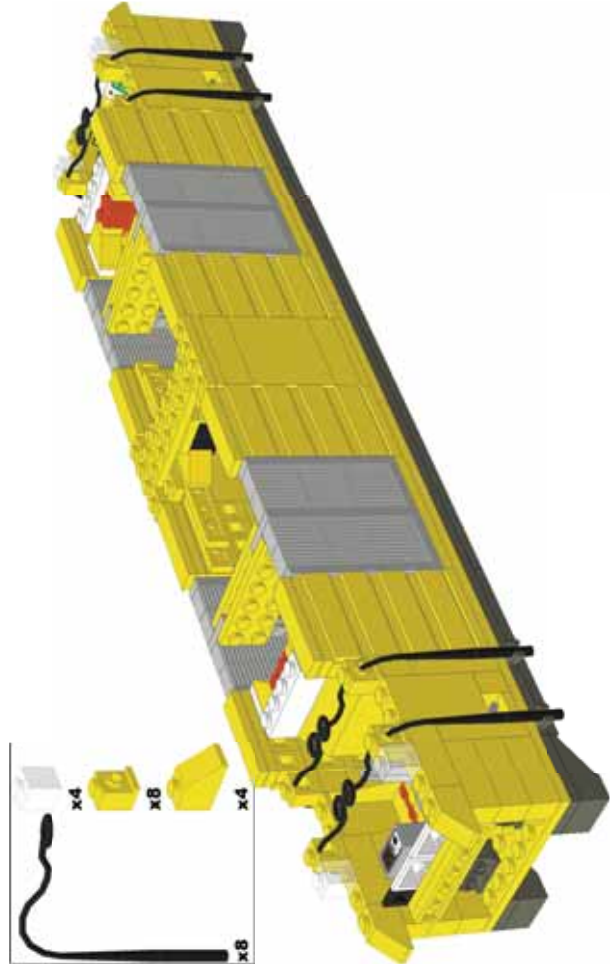









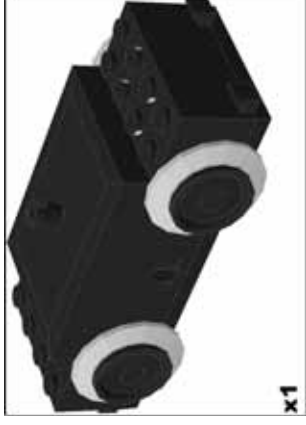

x2

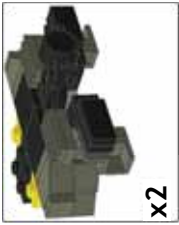
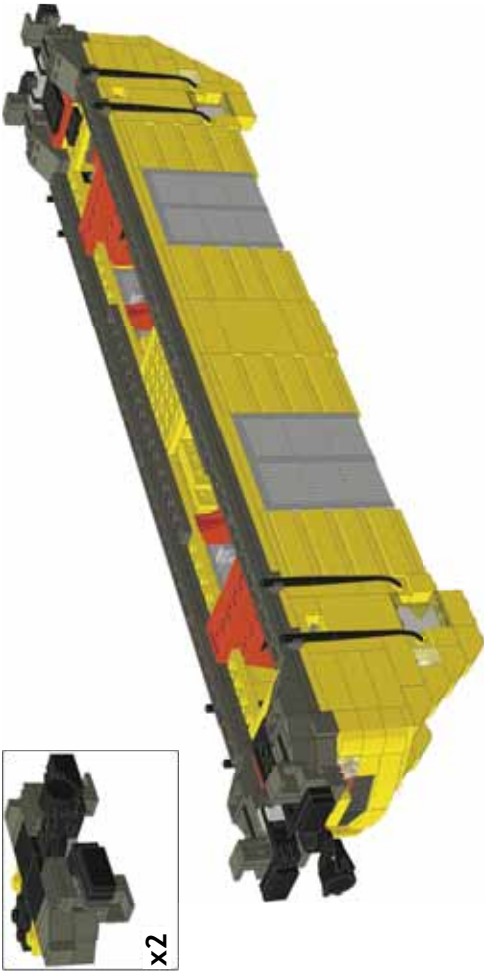

x2

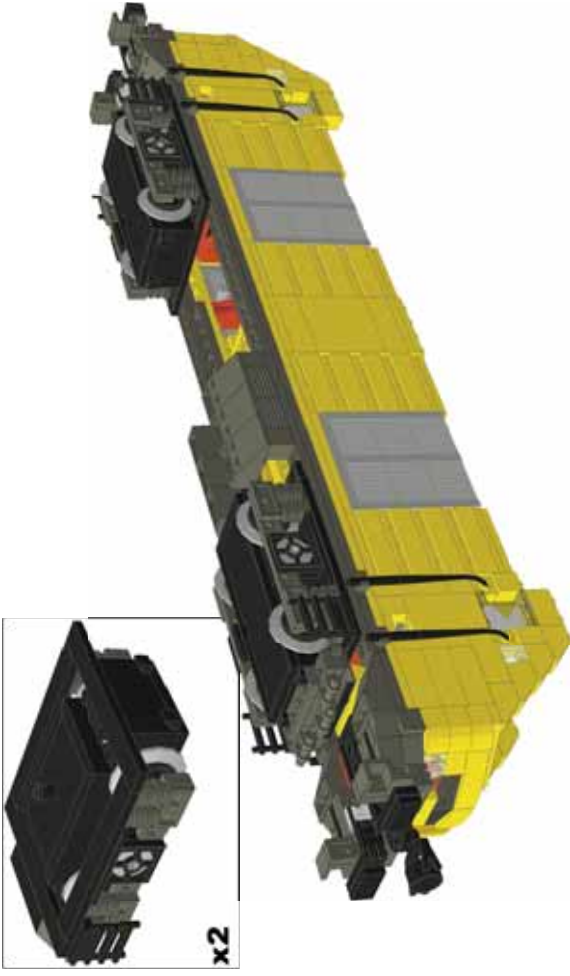

x2

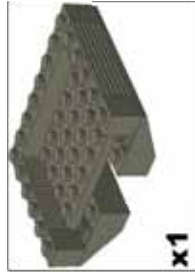

x1

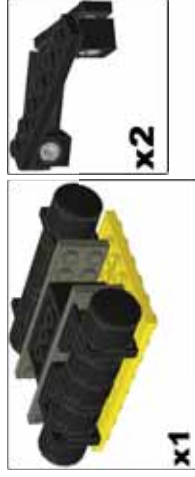

x1



x2

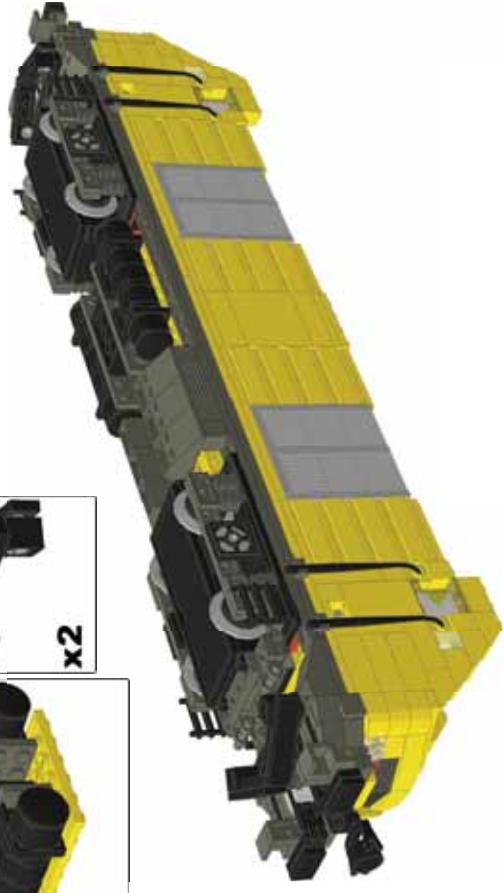

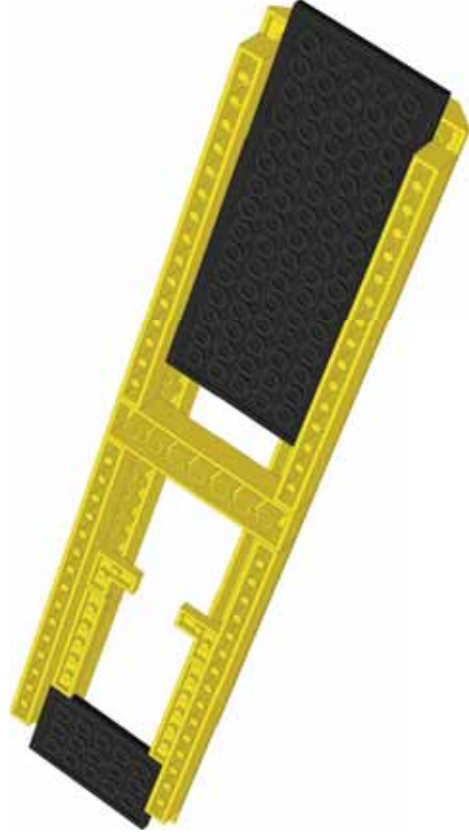
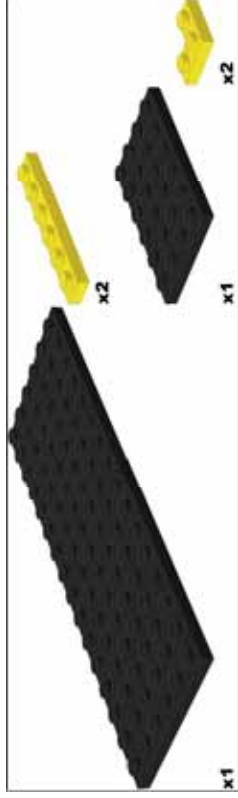
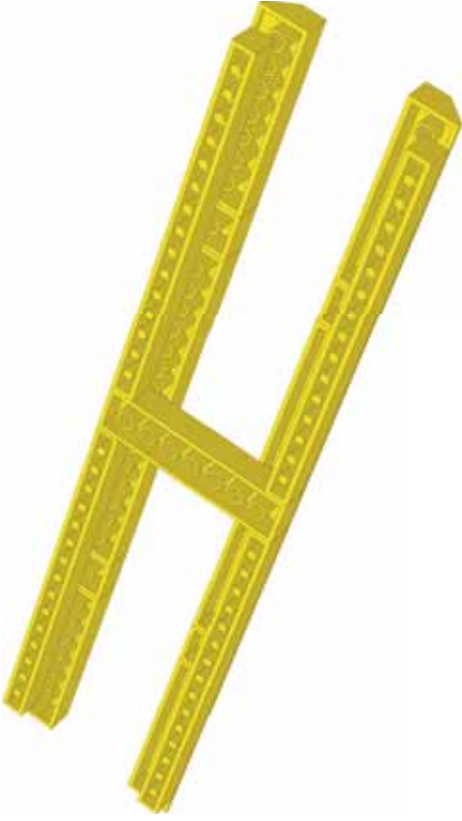
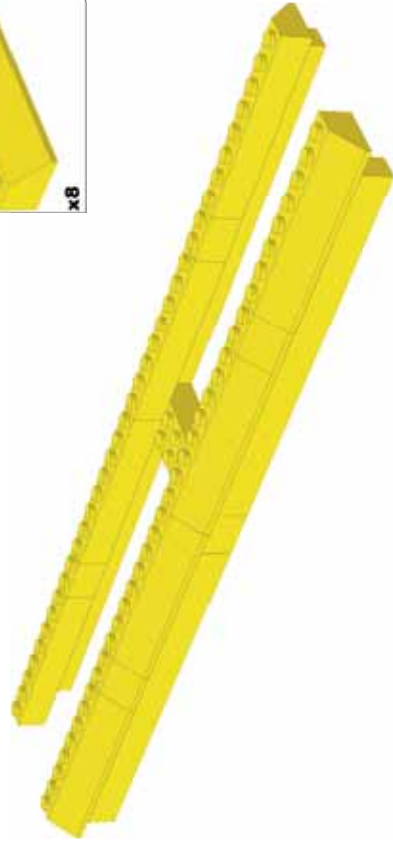
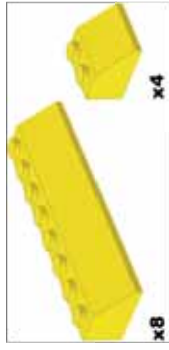
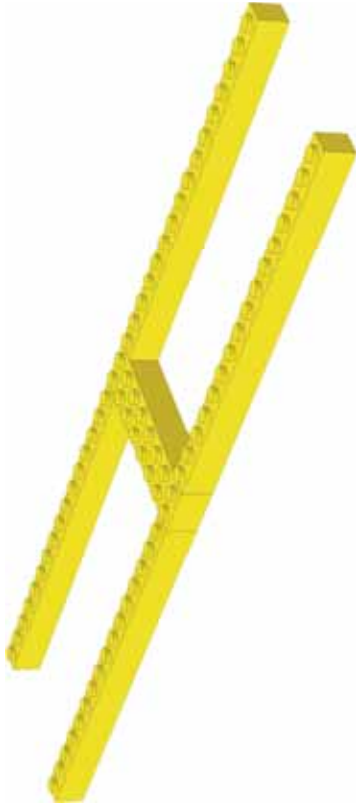
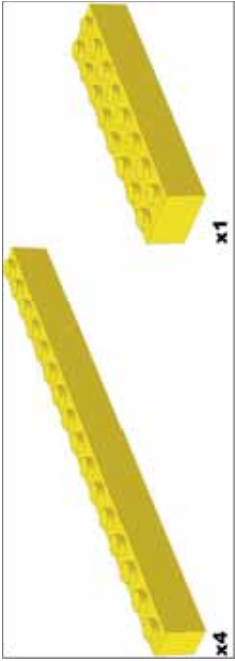



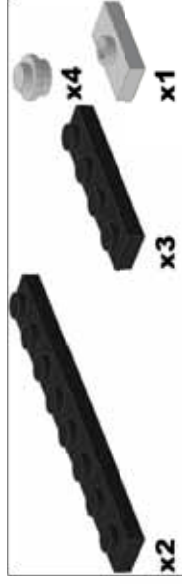
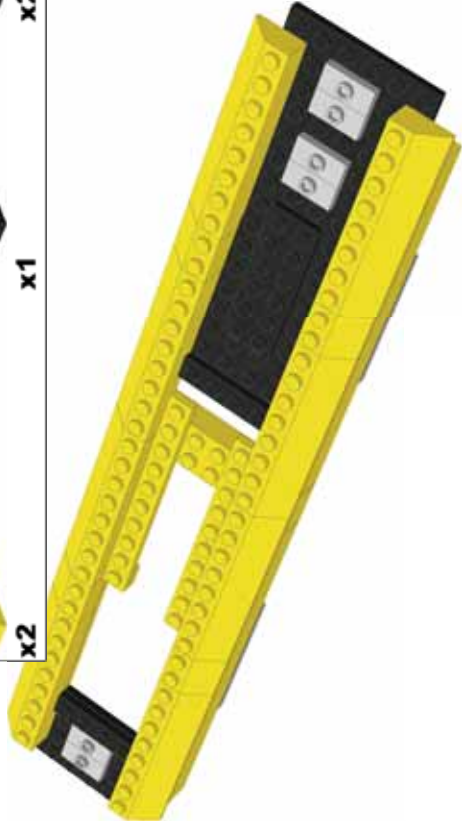
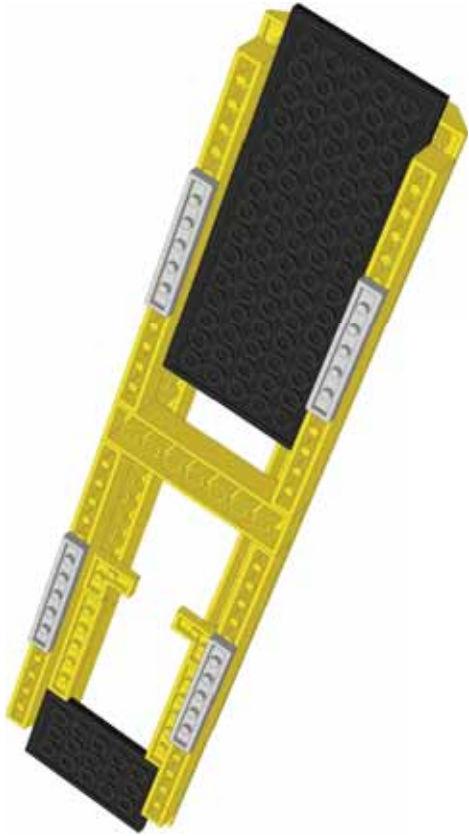

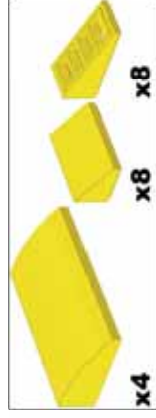
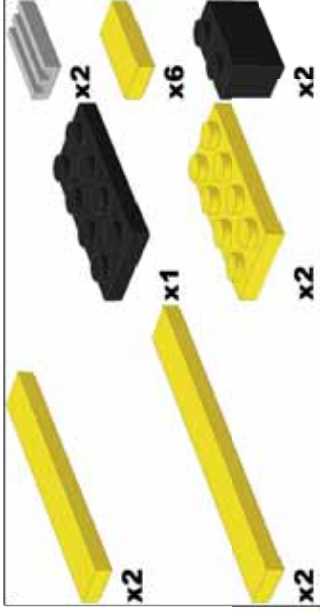
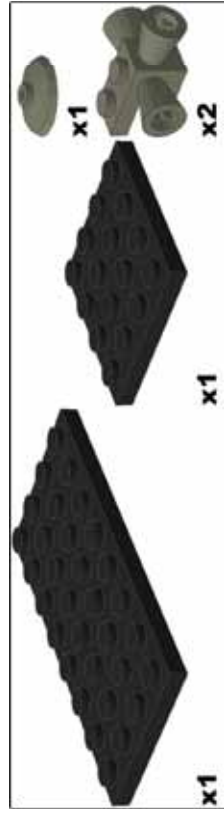
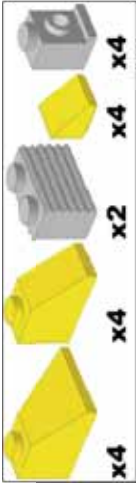

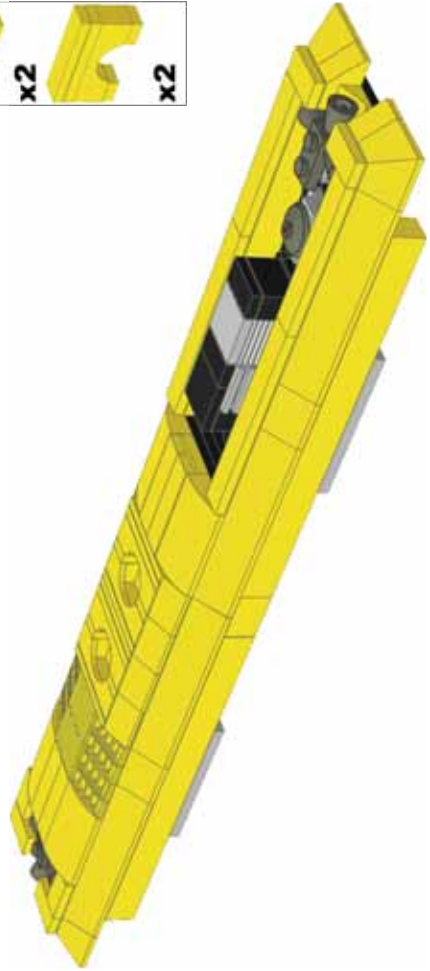
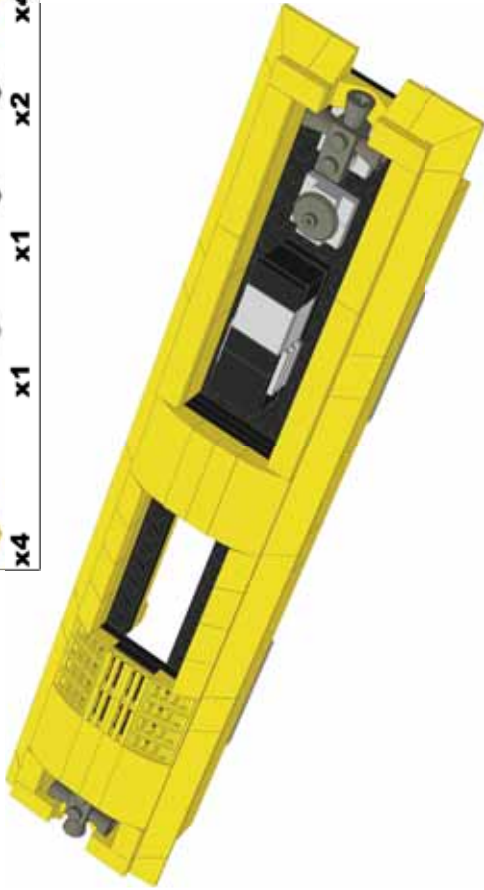
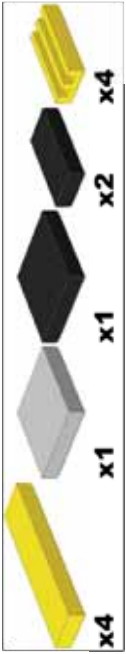



x2

Technic Rotation Joint Ball with Arm Pin and Hole Ends



The two Technic Rotation Joint Ball with Arm Pin and Hole Ends are inserted through the roof into the black Technic plates 2x8 (page 10). The picture features the part, the other one being already in place (left). They are used here as exhaust.



